

# E-Z MOUNT FENDER BRACKET ORDER INFORMATION

## ADJUSTABLE FENDER BRACKETS

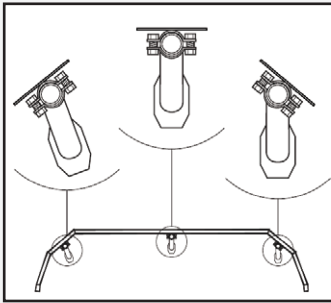

All three E - Z fender brackets are adjustable in length from 27" to 30".

Stainless steel cap screw mounting plate bolts are included.

### Installation Notes:

- ▲ Backing plate is designed to be used as a template to drill holes in fender.
- ▲ When installing the 3/8" x 2 1/4" bolts, it is recommended that the bolts are not over tightened, 10inch lbs. torque.
- ▲ It is necessary to bend TAB Lock-washers downward into the bolt to prevent unwinding.
- ▲ Torque 5/8" nuts to 150 ft/lbs.

### E - Z Fender Bracket - Black - 4" Model

Part #

567

Weight: 12 lbs

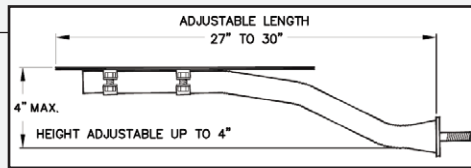

### E - Z Fender Bracket - Black - 8" Model

Part #

568

Weight: 12 lbs

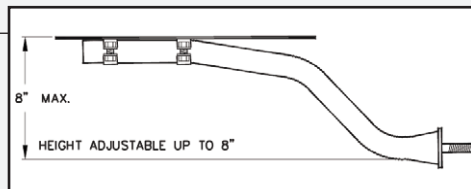

### E - Z Fender Bracket - Black - 10" Model

Part #

569

Weight: 12 lbs

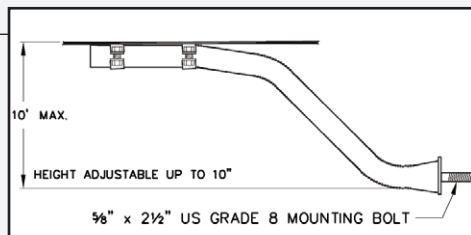

## STRAIGHT FENDER BRACKETS

This is a Universal Bracket-designed to mount outside any fender.

### Features:

- ▲ Mounts solidly to frame with single grade 8 bolt
- ▲ 574 Mounts to the existing stub shaft or the 573 post, making those hard installations easier
- ▲ Bracket Mounts 1" off Fender so rocks and gravel can pass through

### Mounting Post - Zinc Plated

Part #

573-2 Pair

Weight: 5 lbs

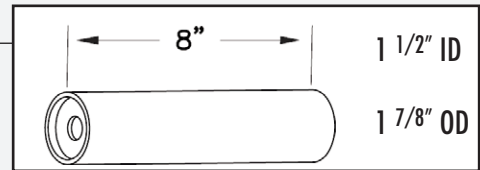

### Post Mount Bracket - Chrome

Part #

574

Weight: 8 lbs

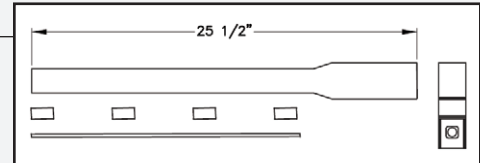

### Straight Bracket

Part #

575 Black

Weight: 12 lbs

576 Chrome

Weight: 12 lbs

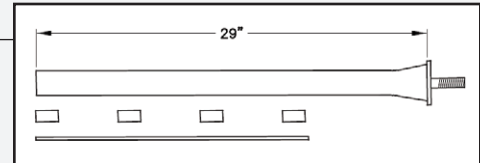

### Frame Spacer

Part #

1560 Black

Weight: 1 lbs

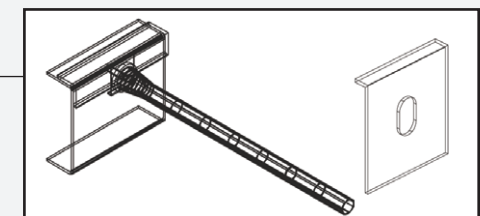

- ▲ If your EZ-Mount bracket, mounted in the center and on the fifth wheel plate does not have full contact, the 1560 will allow a fix for this
- ▲ Just mount with the "leg" below (see the drawing) the fifth wheel plate and then mount the bracket through the plate making a 100% contact mount for the bracket.
- ▲ The 1560 package includes 2 plates, one for each side and instructions on how to use.

Models and/or Specifications Subject to Change Without Notice.

F.O.B. - Atlanta GA, Birmingham AL, Dallas TX, Henderson CO, Houston TX, Minneapolis MN, Nashville TN, Pittsburgh PA, Portland OR, Sacramento CA, Kansas City KS, Calgary, AB (CA), Toronto, ON (CA)

Copyright © 2016 Merritt Aluminum Products Company. All Rights Reserved.



Follow us on Facebook!! 

- ▲ 6 Models to choose from, allowing you to adapt a bracket to your application.
- ▲ 3 Adjustable models, giving you greater flexibility.
- ▲ All E-Z Fender Mount brackets have the time tested single mounting bolt. Very Quick- Very Easy!

- ▲ 3 Straight models available with rubber spacers, which provide 1" clearance between the fender and bracket, allowing dirt and gravel to pass through... makes cleaning easier.
- ▲ All hardware is supplied with each bracket for mounting.

- ▲ Fender to bracket mounting hardware is made from stainless steel.
- ▲ Mounting instructions included with each bracket for installation.
- ▲ Stocked in all Merritt warehouse locations.

# E-Z MOUNT FENDER BRACKET



Straight E-Z Mount



Straight E-Z Mount



Post E-Z Mount Bracket



8" Post Mount